

Assembly and maintenance manual

Type RDBR280-500-E/E-H

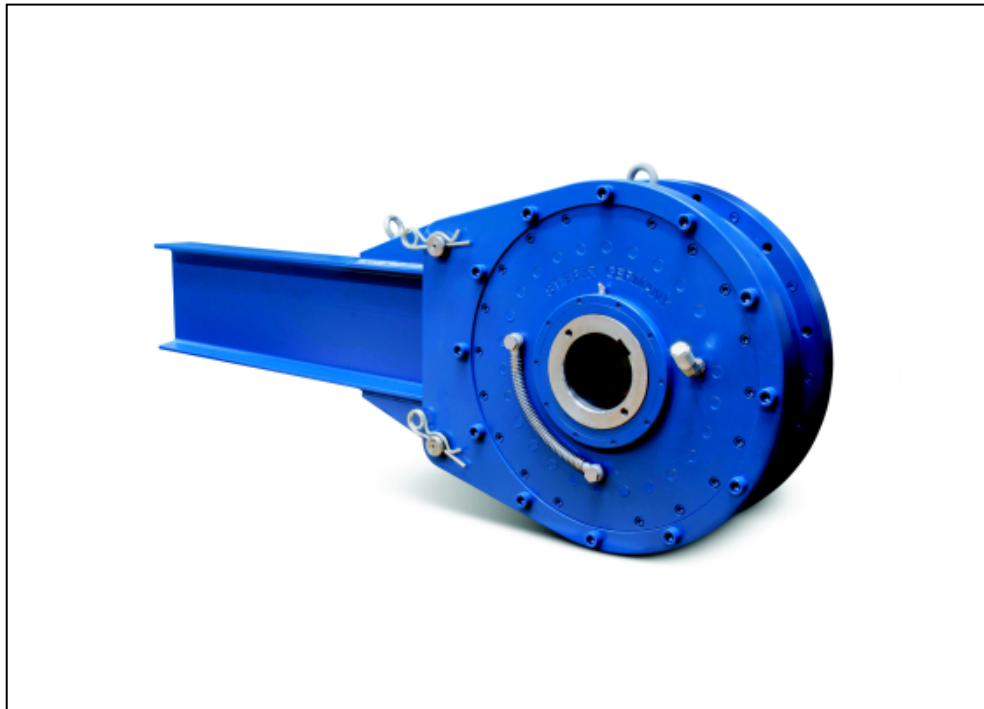

Hatschekstr.36
69126 Heidelberg
Germany
Tel +49(0)6221 30470
Tel +49(0)6221 304731
info@stieber.de
www.stieber.de

Date of issue: 31.08.2016 GB

Revision: 3 31.03.2017 GB

U:\EngUsers\IProduktDoku\1AAA_Einbauerklärung_Montage-und Wartungsanleitung_Konformitätserklärung\1AAA_Montage- und Wartungsanleitungen\Original_Worddatei\M1073E_3_RDBR280-500-E-E-H.docx



General safety instructions





	WARNING	<p>Risk of injury due to moving components! Rotating driven components can cause the most severe injuries. Therefore, during operation:</p> <ul style="list-style-type: none"> ➤ It is strictly forbidden for persons to loiter in the hazard area or in its immediate vicinity ➤ Do not disable, render unusable or circumvent safety equipment and/or safety functions <p>Prior to entering the hazard area:</p> <ul style="list-style-type: none"> ➤ Switch off the power supply and secure it against being switched on again ➤ Wait for lagging components to come to a standstill
	DANGER!	<p>Danger due to improper operation!</p> <ul style="list-style-type: none"> ➤ Modifications to the backstop are not permitted and may impair safety ➤ All tasks may only be performed by personnel with the requisite training and expertise ➤ Repairs and maintenance tasks may only be performed when the machine is at a standstill. To this end, the machine is to be secured against a restart
	WARNING	<p>Risk of injury due to the backstop falling down or tipping over! The weight of the backstop can injure people and cause severe crushing. Therefore:</p> <ul style="list-style-type: none"> ➤ Use a pallet on which the backstop can be moved with a forklift ➤ Use suitable lifting gear for lifting (slings, etc.), which is able to support the weight of the backstop
	WARNING	<p>Risk of injury due to incorrect assembly! Faulty installation and maintenance can cause severe property damage and personal injury. Installation, maintenance, and repair work may only be performed by personnel with the requisite training and expertise.</p>
	WARNING	<p>Risk of injury for insufficiently qualified personnel! Improper handling can cause significant personal injury and property damage. Therefore:</p> <ul style="list-style-type: none"> ➤ Only ever have tasks performed by those persons to whom the tasks have been assigned

Table of contents	Page
General safety instructions	2
1 General.....	5
1.1 Information relating to the assembly and maintenance manual.....	5
1.2 Explanation of symbols	5
1.3 Manufacturer	6
1.4 Labeling	6
1.5 Environmental protection	6
2 Safety:	6
2.1 Intended use	6
2.2 Responsibility of the operator	7
2.3 Assembly and maintenance personnel	7
2.4 Personal protective equipment	7
2.5 Limitations of use	8
Structure and function.....	8
2.6 Structure	8
2.7 Function	11
2.7.1 Lockout operation of a backstop:.....	11
2.7.2 Overrun operation of a backstop:	11
2.7.3 Operating mode	11
3 Transport and packaging	12
4 Storage.....	12
4.1 Short-term storage	12
4.2 Long-term storage.....	13
5 Installation	13
5.1 Lubrication	13
5.2 Assembly	13
5.3 Changing the direction of rotation	16
5.4 Assembling the cover (optional only)	16
5.5 Assembling the hydraulic breakaway device	16
6 Operation	18
6.1 Removing the backstop	18
7 Maintenance	19
7.1 Backstop maintenance.....	19
8 Disassembly	21

9	Disposal	22
10	Faults.....	22
11	Spare parts	22

1 General

1.1 Information relating to the assembly and maintenance manual

This assembly and maintenance manual provides important information regarding the installation and commissioning of the backstop.





The prerequisite for safe operation is compliance with all of the stated safety and handling instructions.

Moreover, the relevant local accident protection guidelines and general safety provisions for the field of application of the backstop are to be complied with.

Read the assembly and maintenance manual carefully prior to installation and commissioning. The manual is a product component and must be kept in the immediate vicinity of the installation site and be accessible to personnel at all times. Furthermore, all safety instructions stated in the assembly and maintenance manual are to be observed.

1.2 Explanation of symbols

Warnings are marked throughout this assembly and maintenance manual by symbols. These warning symbols are introduced by signal words that indicate the extent of the danger. Comply with these warning symbols under all circumstances and act with due care and attention to avoid accidents, personal injury, and property damage.

	Danger!	...indicates an imminently dangerous situation that can be fatal or cause severe injuries if it is not averted.
	WARNING	...indicates a potentially dangerous situation that can be fatal or cause severe injuries if it is not averted.
	ATTENTION!	...indicates a potentially dangerous situation that can cause minor or light injuries if it is not averted.
	CAUTION	...indicates a potentially dangerous situation that can cause property damage if it is not averted.
	NOTE	... highlights helpful tips and recommendations as well as information for efficient and fault-free operation.

1.3 Manufacturer

STIEBER GMBH, 69126 Heidelberg, Hatschekstr. 36, Germany
Tel +49 (0) 6221 3047-0, Fax -31

1.4 Labeling

Front of cover

- Manufacturer's name

Outer ring, peripheral side/type plate with

- Order no./SN:
- Type designation
- Slip torque T_R
- Date of manufacture MM.XXXX
- Direction of rotation

1.5 Environmental protection

Energy: The backstop does not use any electrical energy.

Materials: Steel, nonferrous metals

Recycling: Steel parts are up to 100% recyclable.

2 Safety:

2.1 Intended use

Type RDBR280-500-E/E-H backstops are automatic torque-limiting backstops that are dependent on the direction of rotation. They transmit the torque in a force-locked manner. Type RDBR280-500-E/E-H backstops are primarily used as torque-limiting backstops as well as load-balancing stops in multiple drives, for example in conveyor systems.

Torque-limiting backstops may only be operated within the limitations of use outlined in Section 2.5.

All of the specifications stated in the assembly and maintenance manual must be strictly adhered to.

Any claims due to damage arising from improper use are excluded. The operator carries sole liability for all damage arising from improper use.

2.2 Responsibility of the operator

The operator of the machine in which the backstop is installed is subject to the legal obligations concerning occupational safety.

The valid provisions for the site of operation as well as the safety and accident prevention regulations of the trades' association are to be observed. In particular, this means that the operator:

- is aware of the valid occupational safety provisions
- implements the necessary behavioral requirements for operation of the machine in which the backstop is installed at the site of operation
- clearly defines responsibilities for installation, operation, maintenance, and cleaning of the machine in which the backstop is installed
- ensures that all staff members who work at or with the machine in which the backstop is installed have read and understood the operating manual. Moreover, the operator must, at regular intervals, provide training for personnel on how to handle the machine in which the backstop is installed, and inform them of the potential dangers. In addition, the operator is responsible for ensuring that the machine in which the backstop is installed:
 - is always in perfect technical condition
 - is maintained in accordance with the specified maintenance intervals
 - has all its safety equipment checked regularly for completeness and functionality

2.3 Assembly and maintenance personnel

	WARNING	<p>Risk of injury for insufficiently qualified personnel! Improper handling can cause significant personal injury and property damage. Therefore:</p> <ul style="list-style-type: none"> ➤ Only ever have tasks performed by those persons to whom the tasks have been assigned
---	----------------	---

Qualified personnel are those persons who, owing to their training, experience and instruction as well as their knowledge of relevant standards, provisions, accident prevention regulations and operating conditions, have been authorized by the person responsible for the safety of the plant to perform the requisite tasks and are able to recognize and avoid potential dangers in doing so. Knowledge of first-aid measures and on-site emergency equipment must also be included.

2.4 Personal protective equipment

In order to minimize health risks, it is necessary to wear personal protective equipment when handling the machine in which the backstop is installed.

The necessary protective equipment such as work shoes, gloves, safety goggles, etc. is to be put on prior to all tasks and kept on during the task.

2.5 Limitations of use

Type RDBR...E RDBR...-E-H	Max. bore	Max. permis- sible slip torque [Nm]	Max. permissible overrun rotation speed [min ⁻¹]	Max. permissible reverse rotation speed [min ⁻¹]
280	150	50,000	175	175
300	160	75,000	150	150
360	190	120,000	130	130
420	240	180,000	120	120
500	320	330,000	100	100

- Limits for ambient temperature: -20°C to +45°C
- Max. operating temperature during normal operation (may be higher during slip): 90°C
- Overrunning: Machine shaft (inner ring)
- Required Machine shaft tolerance: d = h7 or f6
- Lubrication:
 - Oil lubrication at
 - Ambient temperature up to 25°C (operating temperature 70°C) ISOVG68
 - Ambient temperature up to 45°C (operating temperature 90°C) ISOVG100

Structure and function

2.6 Structure

Backstop			
Item 1	Free wheel	Item 12	Oil gauge
Item 2	Flange	Item 13	Ventilation
Item 3	Torque support	Item 14	Threaded connection (cap)
Item 4	Bolt	Item 15	Hydraulic connection
Item 5	Split pin	Item 17	Oil drain plug
Item 6	Eye bolt	Item 18	Oil filling plug
Item 7	Cylinder screws	Item 19	Labyrinth seal with grease nipple
Item 8	Inner ring (free wheel)		

Table 1

Side view

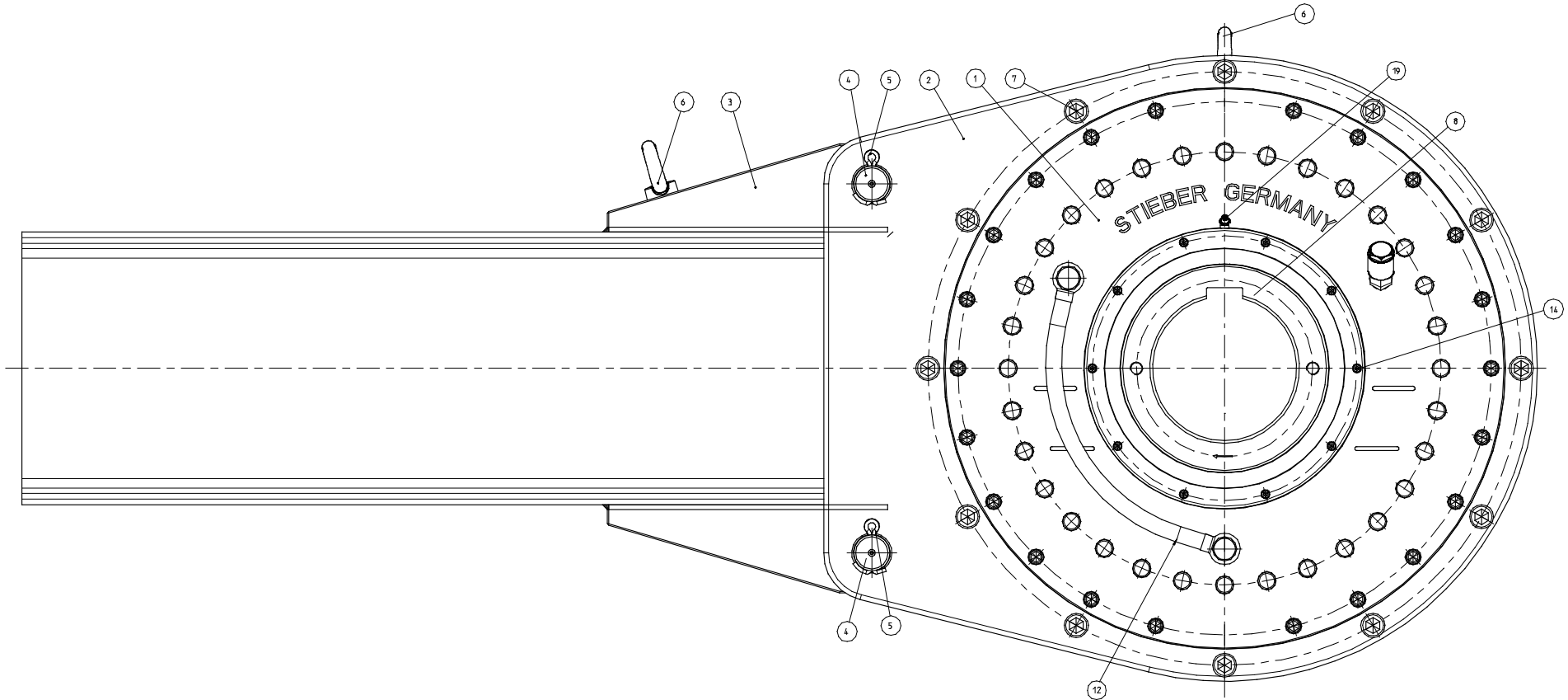
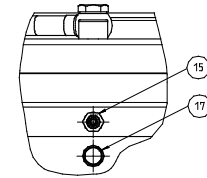

Fig. 1a Structure

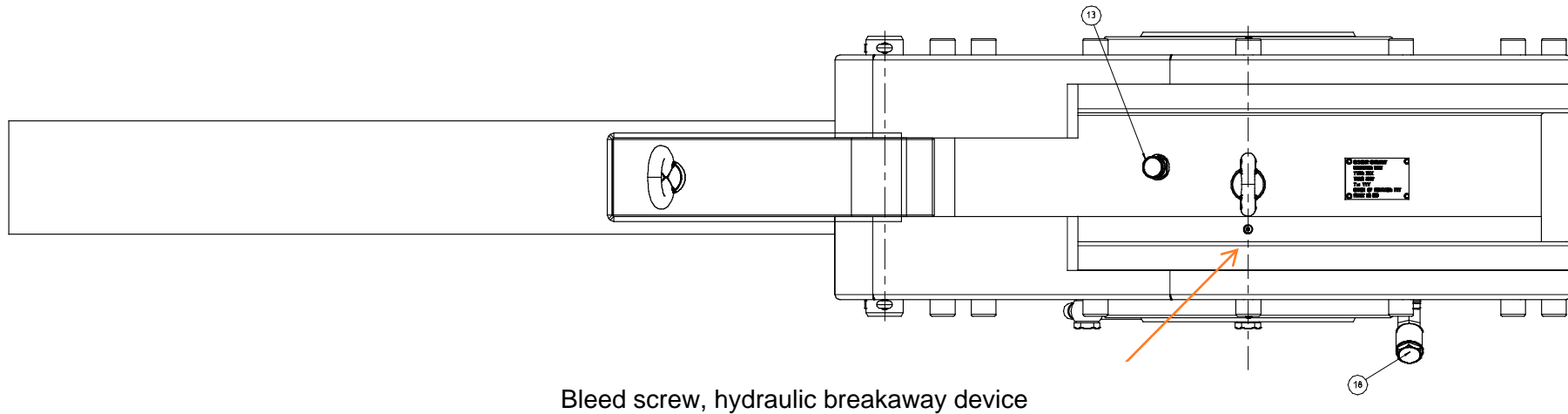

Fig. 1b Structure

2.7 Function

2.7.1 Lockout operation of a backstop:

When the machine shaft is operated in inverse direction, the machine shaft and the torque-supporting machine element are connected to each other in a force-locked manner by the backstop. A torque (lock-up torque) is transmitted in this operating condition. The torque to be transmitted is limited by means of a torque limiter that is integrated in the backstop; this limit is a factory-set peak value (breakaway torque). The torque limiter is fitted with a hydraulic breakaway device, which is used to completely dissipate the lock-up torque. The breakaway device may only be triggered in an emergency or for maintenance purposes.

2.7.2 Overrun operation of a backstop:

If the machine shaft is operated in the overrun direction, the torque-limiting backstop automatically releases the force-locked connection between the machine shaft and the torque-supporting machine element.

2.7.3 Operating mode

RDBR280-500-E/E-H model free wheels are fitted with individually spring-loaded clamp rollers. Spring-loading ensures that all clamp rollers are continuously in contact with the free wheel's inner and outer ring and are thus ready for operation. If the free wheel inner ring (see Fig. 2) is turned in the pulling direction, the rollers create a frictional connection between the inner and outer ring.

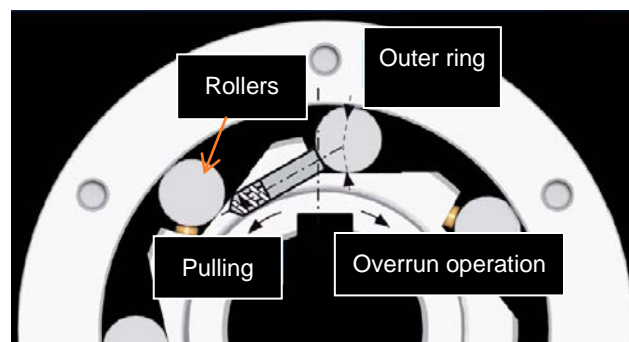

Fig. 2 Pulling/Overrun operation

Overrun operation is carried out if the inner ring is turned in the overrun direction. This interrupts the frictional connection (see Fig. 2) between the inner and outer ring.

The integrated torque limiter consists of a spring preloaded multi-disk brake, which transmits the torque in a force-locked manner up to a preset value (breakaway torque) and then slips. The multi-disk brake is oil-lubricated.

To protect the shaft seal, a grease-filled labyrinth seal (Item 19) is used (see lubrication instructions in chapter 5.1) that must be relubricated in depending on the conditions of use.

Type RDBR280-500-E-H torque limiter backstops have a hydraulic breakaway device that can be used to precisely dissipate the applied torque. In the process, the hydraulic pressure counteracts the spring preload of the multi-disk brake and thus reduces the lock-up torque. The hydraulic pressure can be reduced up to the point that the lock-up torque is completely dissipated. The hydraulic pressure can be applied either by a hydraulic supply (maximum pressure 200 bar) provided by the customer or by means of a separately sold Stieber hydraulic unit (not shown in Fig. 1).

3 Transport and packaging

	<p>WARNING</p>	<p>Risk of injury due to the backstop falling down or tipping over! The weight of the backstop can injure people and cause severe crushing. Therefore:</p> <ul style="list-style-type: none"> ➤ Use a pallet on which the backstop can be moved with a forklift ➤ Use suitable lifting gear for lifting (slings, etc.), which is able to support the weight of the backstop
---	-----------------------	--

	<p>NOTE</p>	<p>The local provisions regarding the disposal of transport and packaging materials are to be observed.</p>
---	--------------------	---

The type RDBR280-500-E/E-H torque limiter backstop is packed in VCI bubble wrap to help prevent corrosion damage. The backstop and lever are shipped separately on pallets.

Transport damage to the packaging and/or the backstop is to be reported to the respective transit company without delay.

The backstop must be unpacked in a clean and dry environment.

4 Storage

4.1 Short-term storage

The type RDBR280-500-E/E-H torque limiter backstop is packed in VCI bubble wrap. The VCI bubble wrap is to be checked at regular intervals. The frequency of these intervals is dependent on the environmental conditions (temperature, moisture, salt content of the air, etc.) at the storage site.

The maximum storage period (short-term storage) is 6 months. Moreover, the backstop must have long-term storage corrosion protection applied to it.

Store packages under the following conditions:

- Do not keep outdoors
- Keep dry and free from dust
- Do not expose to aggressive media
- Keep away from direct sunlight
- Avoid mechanical shocks and vibrations
- Storage temperature: -10 to +60°C
- Relative humidity: max. 95%, non-condensing

4.2 Long-term storage

For long-term storage, the backstop must be shrink-wrapped with a desiccant and provided with a hygroscope. The corrosion protection must be checked after a period not exceeding one year or else depending on the environmental conditions (temperature, moisture, salt content of the air, etc.) at the storage site.

Store packages under the following conditions:

- Do not keep outdoors
- Keep dry and free from dust
- Do not expose to aggressive media
- Keep away from direct sunlight
- Avoid mechanical shocks and vibrations
- Storage temperature: -10 to +60°C
- Relative humidity: max. 95%, non-condensing

5 Installation

5.1 Lubrication

The type RDBR280-500-E/E-H torque limiter backstop is oil-lubricated. The oil selected must meet Stieber factory standards (see "Limitations of use") or be selected in consultation with Stieber.

The oil selected has a direct influence on the brake and in turn on the preset braking torque.

To protect the shaft seal, a grease-filled labyrinth seal (Item 19) is used. The maintenance intervals depend on the environmental and operating conditions. The grease nipples (Item 19) must be relubricated with a conventional lubricant of class NLGI 2 until fresh grease oozes out of the gap between the shaft and the labyrinth seal.

If possible, the shaft should be rotated.

When using the cover (fig. 5), there is no labyrinth seal installed on the respective side, so no relubrication is needed.

Upon delivery, the seals are sufficiently lubricated with MoS2 grease (black).

5.2 Assembly

	WARNING	Risk of injury due to incorrect assembly! Faulty installation and maintenance can cause severe property damage and personal injury. Installation, maintenance, and repair work may only be performed by personnel with the requisite training and expertise.
---	----------------	---

	WARNING	<p>Risk of injury due to moving components! Rotating driven components can cause severe injuries. Therefore, during operation:</p> <ul style="list-style-type: none"> ➤ It is strictly forbidden for persons to loiter in the hazard area or in its immediate vicinity ➤ Do not disable, render unusable, or circumvent safety equipment and/or safety functions <p>Prior to entering the hazard area:</p> <ul style="list-style-type: none"> ➤ Switch off the power supply and secure it against being switched on again ➤ Wait for lagging components to come to a standstill
---	----------------	--

	WARNING	<p>Risk of injury due to the backstop falling down or tipping over! The weight of the backstop can injure people and cause severe crushing. Therefore:</p> <ul style="list-style-type: none"> ➤ Use a pallet on which the backstop can be moved with a forklift ➤ Use suitable lifting gear for lifting (slings, etc.), which is able to support the weight of the backstop
---	----------------	--

The backstop is typically installed on the gear shaft without a torque support. The torque support is then fastened to the flange (Item 2).

The flange itself is installed on the outer ring of the free wheel and can also be fitted offset by approx. 15° as needed (Item 7).

Procedural steps:

- Release the cylinder screws (7) from the flange (2)
- Turn the flange into the desired position (in 15° increments)
- Secure the flange with the cylinder screws (7)

The backstop is assembled as follows:

Procedural steps:

- Lift the backstop out of its packaging and place on a suitable installation surface.
To do so, use the eye bolts included in the scope of delivery (Item 6)
- Lift the backstop using suitable lifting gear and push it over the inner ring onto the oiled shaft
To do so, use the included eye bolt (Item 6) on the flange (Item 2). The inner ring (8) can be turned to an idling direction (direction of the arrow)

	NOTE	Only press on the inner ring when pressing the free wheel onto the shaft.
---	-------------	---

- Fasten the free wheel (Item 1) axially on the machine shaft

- Lift the torque support (Item 3) using suitable lifting gear
- Turn the backstop into the idling direction to bring it into position. Push the torque support (Item 3) into the flange (Item 2) and align it with the bolt holes (Item 4/5)
- Insert the bolts (Item 4) in the bolt holes and secure them on both sides using a split pin (Item 5)
- Fasten the torque support (Item 3) in both directions

**NOTE**

The torque support must not be tensioned once it is installed.

- Check the overrunning direction
- Fill with oil. To do so, carry out the following procedural steps:
 - Unfasten the oil filling plug (Item 18)
 - While the device is at a standstill, fill with lubricant at least to the middle of the oil level marking (Item 12)
If the oil level falls below the lower marking during operation, oil in the specified quality must be topped off until the original oil level is reached again
 - Tighten the oil filling plug (Item 18)

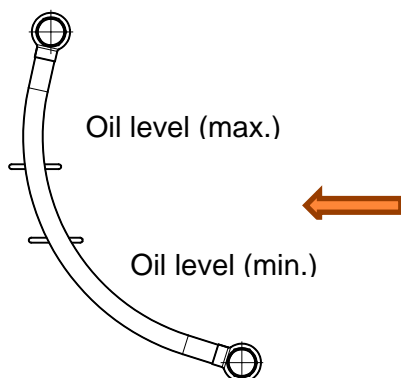

Fig. 4 Oil level control in operation

The backstop is can also be mounted to the gear shaft with an attached torque support. The torque support is then fastened to the flange (Item 2).

The torque support alignment is either horizontal (factory-set) or carried out according to customer specifications.

5.3 Changing the direction of rotation

Only **Stieber** can change the direction of rotation.

5.4 Assembling the cover (optional only)

The cover is also used for protection against contamination and damage.

The cover is mounted to the already installed stop.

Procedural steps:

- Remove the screw connection (Item 14)
- Remove the labyrinth
- Center the cover on the threaded connection bores and fasten it

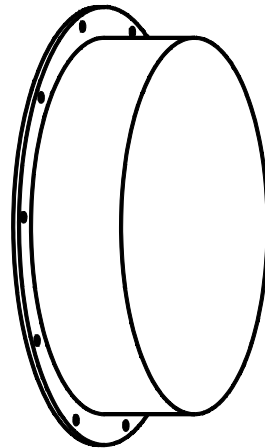

Fig. 5 Cover

5.5 Assembling the hydraulic breakaway device

The following points are to be observed when assembling the hydraulic breakaway device:

Hydraulic system provided by the customer:

- Maximum pressure 200 bar
- Connection to the hydraulic connection (Item 15) DIN 2353 M14 x 1.5 24° inside taper
- Ventilation via the bleed screw (Item 13)



CAUTION

During normal operation, pressure must not increase (e.g. due to temperature changes).

Hand pump:

- The hydraulic block from Stieber (see Fig. 3) must be used if a hand pump is used. This limits the pressure and makes it possible to use a quick connector for the hand pump
- Mount the hydraulic block securely to a supported location
- Install the hose (pressure and oil resistance at least 200 bar) between the hydraulic block (screw-in connector 24" inside taper DIN 23534) and hydraulic connections (Item 15). Maximum hose length between the block and the stop is 2000 mm (nominal width 6 mm); otherwise, Stieber is to be consulted
- Connect the hydraulic pump to coupling sleeve ISO 7241 A, size 4
- Ventilation via the bleed screw (Item 13)
- Remove the hydraulic pump

**NOTE**

The cracking pressure depends on the preset torque and oil.

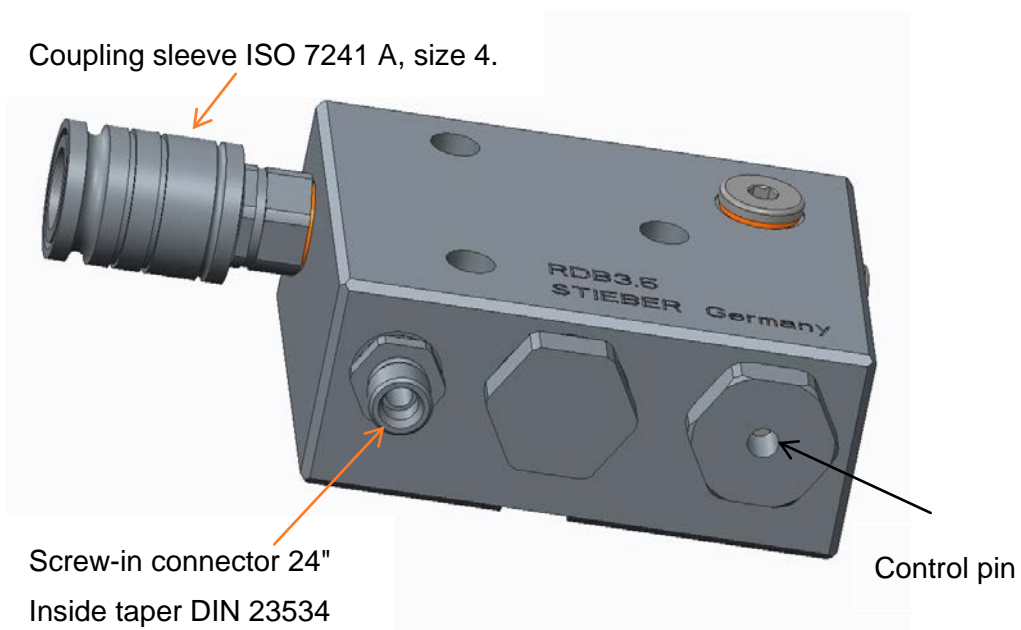



Fig. 3 Hydraulic block

6 Operation

During operation, the oil level in the backstop must lie between the Min and Max marking on the oil level indicator.

6.1 Removing the backstop

	WARNING	Risk of injury for insufficiently qualified personnel! Improper handling can cause significant personal injury and property damage. Therefore: <ul style="list-style-type: none">➤ Only ever have tasks performed by those persons to whom the tasks have been assigned
---	----------------	---

The type RDBR280-500-E/E-H torque limiter backstop can be hydraulically released in case of an emergency or for maintenance purposes.

Hydraulic system provided by the customer:



- Gradually increase the pressure (max. 200 bar) until the backstop is completely open. The pressure that is actually required depends on the oil and preset slip torque
- Afterwards, completely bleed the pressure → the backstop is now ready for use again

Incorporating the hand pump:

- Gradually increase the pressure (max. 200 bar) until the backstop is completely open. The pressure that is actually required depends on the oil and preset slip torque
- Afterwards, completely bleed the pressure → the backstop is now ready for use again

7 Maintenance

7.1 Backstop maintenance

	WARNING	<p>Risk of injury due to incorrect assembly! Faulty installation and maintenance can cause severe property damage and personal injury. Installation, maintenance, and repair work may only be performed by personnel with the requisite training and expertise.</p>
	WARNING	<p>Risk of injury due to moving components! Rotating driven components can cause severe injuries. Therefore, during operation:</p> <ul style="list-style-type: none"> ➤ It is strictly forbidden for persons to loiter in the hazard area or in its immediate vicinity ➤ Do not disable, render unusable, or circumvent safety equipment and/or safety functions <p>Prior to entering the hazard area:</p> <ul style="list-style-type: none"> ➤ Switch off the power supply and secure it against being switched on again ➤ Wait for lagging components to come to a standstill
	WARNING!	<p>Risk of injury for insufficiently qualified personnel! Improper handling can cause significant personal injury and property damage. Therefore:</p> <ul style="list-style-type: none"> ➤ Only ever have tasks performed by those persons to whom the tasks have been assigned

The following inspection and maintenance intervals apply for the backstops:

❖ Relubrication interval

Depending on the surroundings, grease is to be pressed in through every grease nipple (Item 19) to the labyrinth seal until it escapes between the labyrinth and inner ring.

❖ Annual oil change interval

An oil change is to be carried out annually on the type RDBR280-500-E/E-H backstop.

Procedural steps:

- Unfasten the oil filling plug (Item 18)

	NOTE	<p>The local provisions regarding the disposal of lubricants present are to be observed.</p>
---	-------------	--

- Unfasten the oil drain plug (Item 17). Place a suitable oil drip pan (minimum capacity: 3 liters) beneath it
- Allow all of the oil to escape
- Flush the backstop with fresh oil until the escaping oil is clean. Allow all of the oil to escape
- Tighten the oil drain plug (Item 17)
- While the device is at a standstill, fill with lubricant at least to the middle of the oil level marking (see Fig. 4) (Item 12). If the oil level falls below the lower marking during operation, oil in the specified quality must be topped off until the original oil level is reached again
- Tighten the oil filling plug (Item 18)

During operation, the oil level must lie between the two markings when the backstop is at operating temperature.

Depending on the ambient conditions, grease is to be pressed in through every grease nipple (Item 19) to the labyrinth seal until it begins to escape from the crack between the labyrinth and inner ring.

❖ Overhaul interval



The type RDBR280-500-E/E-H torque-limiting backstop must be inspected by Stieber GmbH after an **operating period of 10 years**. To this end, the backstop must be removed and sent to Stieber GmbH.

	WARNING	<p>Risk of injury due to the backstop falling down or tipping over! The weight of the backstop can injure people and cause severe crushing. Therefore:</p> <ul style="list-style-type: none"> ➤ Use a pallet on which the backstop can be moved with a forklift ➤ Use suitable lifting gear for lifting (slings, etc.), which is able to support the weight of the backstop
---	----------------	--

Procedural steps:

- Unfasten the oil drain plug (Item 17). Place a suitable oil drip pan (minimum capacity: 3 liters) beneath it
- Allow all of the oil to escape
- Retighten the oil drain plug (Item 17)
- Release the torque support (Item 3)
- Remove the axial fastening of the inner ring (Item 2)
- Use eye bolts (Item 6) on the flange and torque support, and fasten suitable lifting gear to the eye bolts
- Dismantle the backstop from the shaft

8 Disassembly

	<p>WARNING</p>	<p>Risk of injury due to moving components! Rotating driven components can cause severe injuries. Therefore, during operation:</p> <ul style="list-style-type: none"> ➤ It is strictly forbidden for persons to loiter in the hazard area or in its immediate vicinity ➤ Do not disable, render unusable, or circumvent safety equipment and/or safety functions <p>Prior to entering the hazard area:</p> <ul style="list-style-type: none"> ➤ Switch off the power supply and secure it against being switched on again ➤ Wait for lagging components to come to a standstill
	<p>WARNING</p>	<p>Risk of injury due to the backstop falling down or tipping over! The weight of the backstop can injure people and cause severe crushing. Therefore:</p> <ul style="list-style-type: none"> ➤ Use a pallet on which the backstop can be moved with a forklift ➤ Use suitable lifting gear for lifting (slings, etc.), which is able to support the weight of the backstop
	<p>WARNING!</p>	<p>Risk of injury for insufficiently qualified personnel! Improper handling can cause significant personal injury and property damage. Therefore:</p> <ul style="list-style-type: none"> ➤ Only ever have tasks performed by those persons to whom the tasks have been assigned

Procedural steps:

- Unfasten the oil drain plug (Item 17). Place a suitable oil drip pan (minimum capacity: 3 liters) beneath it
- Allow all of the oil to escape
- Retighten the oil drain plug (Item 17)
- Release the torque support (Item 3)
- Remove the axial fastening of the inner ring (Item 2)
- Use eye bolts (Item 6) on the flange and torque support, and fasten suitable lifting gear to the eye bolts
- Dismantle the backstop from the shaft

9 Disposal



NOTE

The local provisions regarding the disposal of metallic components and any lubricants present are to be observed.

The backstop is comprised of metallic materials that are coated with grease or oil. Metallic materials are fully recyclable. Lubricants and anticorrosive agents are to be disposed of separately. The local disposal provisions are to be observed in this regard.

10 Faults

The manufacturer is to be contacted immediately should any faults arise.

STIEBER GMBH, D-69126 Heidelberg, Hatschekstr. 36, Germany

Tel +49 (0) 6221 3047-0, Fax -31

11 Spare parts



WARNING

Risk of injury due to incorrect spare parts!

Incorrect or faulty spare parts can cause damage, malfunctions or total failure as well as impair safety. Therefore:

- Only use original spare parts from the manufacturer

Procure spare parts only from authorized dealers or from the manufacturer directly.