

**Assembly and maintenance manual**  
**Type AL..G, AL..G-BR**  
**AL..G-FAN, AL..G-BR-FAN**



Hatschekstr.36  
69126 Heidelberg  
Germany  
Phone +49(0)6221 30470  
Fax +49(0)6221 304731  
[info@stieber.de](mailto:info@stieber.de)  
[www.stieber.de](http://www.stieber.de)

Issue date: 01.03.2016 GB  
Revision: 5 26.03.2024 GB

U:\EngUsers\ProduktDoku\1AAA\_Einbauerklaerung\_Wartungsanleitung\_Konformitaetsserklaerung\1AAA\_Wartungsanleitungen\Original\_Worddatei\M1031E\_5\_ALG30-ALG150.docx

## General safety instructions





	<b>WARNING!</b>	<p><b>Risk of injury due to moving components!</b>          Rotating driven components can cause the most severe injuries. Therefore, during operation:</p> <ul style="list-style-type: none"> <li>➤ It is strictly forbidden for persons to loiter in the danger zone or in its immediate vicinity.</li> <li>➤ Do not disable, render unusable or circumvent safety equipment and / or safety functions.</li> </ul> <p>Prior to entering the danger zone:</p> <ul style="list-style-type: none"> <li>➤ Switch off the power supply and secure it against being switched on again.</li> <li>➤ Wait for lagging components to come to a standstill.</li> </ul>
	<b>DANGER!</b>	<p><b>Danger due to improper operation!</b></p> <ul style="list-style-type: none"> <li>➤ Modifications to the foot-mounted clutch are not permitted and may impair safety.</li> <li>➤ All tasks may only be performed by personnel with the requisite training and expertise.</li> <li>➤ Repairs and maintenance tasks may only be performed when the machine is at a standstill. To this end, the machine is to be secured against a restart.</li> </ul>
	<b>WARNING!</b>	<p><b>Risk of injury due to the foot-mounted clutch falling down or tipping over!</b>          The weight of the foot-mounted clutch can injure people and cause severe crushing. Therefore:</p> <ul style="list-style-type: none"> <li>➤ Use a pallet on which the foot-mounted clutch can be moved with a forklift.</li> <li>➤ Use a suitable lifting gear for lifting (slings, etc.) which is able to support the weight of the foot-mounted clutch.</li> </ul>
	<b>WARNING!</b>	<p><b>Risk of injury due to incorrect assembly!</b>          Faulty installation and maintenance can cause severe property damage and personal injury. Installation, maintenance and repair work may only be performed by personnel with the requisite training and expertise.</p>
	<b>WARNING!</b>	<p><b>Risk of injury for insufficiently qualified personnel!</b>          Improper handling can cause significant personal injury and property damage. Therefore:</p> <ul style="list-style-type: none"> <li>➤ Only ever have tasks performed by those persons to whom the tasks have been assigned.</li> </ul>

Table of contents	Page
<b>General safety instructions .....</b>	<b>2</b>
<b>1 General.....</b>	<b>5</b>
1.1 Information relating to the assembly and maintenance manual .....	5
1.2 Explanation of symbols .....	5
1.3 Manufacturer.....	6
1.4 Labeling .....	6
1.5 Environmental protection .....	6
<b>2 Safety .....</b>	<b>6</b>
2.1 Intended use .....	6
2.2 Responsibility of the operator.....	6
2.3 Assembly and maintenance personnel.....	7
2.4 Personal protective equipment.....	7
2.5 Limitations of use .....	8
<b>3 Structure and function .....</b>	<b>10</b>
3.1 Structure of foot-mounted clutch .....	10
3.2 Function .....	12
3.2.1 Operating mode: .....	12
3.2.2 Overrun operation: .....	12
3.2.3 Functioning of the foot-mounted clutch:.....	12
<b>4 Transport and packaging.....</b>	<b>14</b>
<b>5 Storage.....</b>	<b>14</b>
5.1 Short-term storage .....	14
5.2 Long-term storage.....	15
<b>6 Installation .....</b>	<b>15</b>
6.1 Testing the direction of rotating .....	15
6.2 Assembly .....	16
6.3 Lubrication .....	17
6.4 Mounting example.....	18
<b>7 Commissioning .....</b>	<b>18</b>
<b>8 Operation .....</b>	<b>19</b>
8.1 Oil level control .....	20
<b>9 Maintenance .....</b>	<b>20</b>
9.1 Oil change.....	20

**10 Disassembly .....21**

**11 Disposal .....22**

**12 Faults .....22**

**13 Spare parts .....22**

**14 Accessory .....23**

    14.1 Hand brake .....23

## 1 General

### 1.1 Information relating to the assembly and maintenance manual

This assembly and maintenance manual provide important information regarding the installation and commissioning of the foot-mounted clutch of type AL..G, AL..G-BR, AL..G-FAN, AL..G-BR-FAN.





Prerequisite for safe operation is compliance with all of the stated safety and handling instructions.

Moreover, the relevant local accident protection guidelines and general safety provisions for the field of application of the foot-mounted clutch are to be complied with.

Read the assembly and maintenance manual carefully prior to installation and commissioning. It is a product component and must be kept in the immediate vicinity of the installation site and be accessible to personnel at all times. Furthermore, all safety instructions stated in the assembly and maintenance manual are to be observed.

### 1.2 Explanation of symbols

Warnings are marked throughout this assembly and maintenance manual by symbols. These warning symbols are introduced by signal words which indicate the extent of the danger. Comply with these warning symbols under all circumstances and act with due care and attention to avoid accidents, personal injury and property damage.

	<b>Danger!</b>	...indicates an imminently dangerous situation which can be fatal or cause severe injuries if it is not averted.
	<b>WARNING!</b>	...indicates a potentially dangerous situation which can be fatal or cause severe injuries if it is not averted.
	<b>ATTENTION!</b>	...indicates a potentially dangerous situation which can cause minor or light injuries if it is not averted.
	<b>CAUTION!</b>	...indicates a potentially dangerous situation which can cause property damage if it is not averted.
	<b>NOTE!</b>	... highlights helpful tips and recommendations as well as information for efficient and fault-free operation.

### 1.3 Manufacturer

STIEBER GmbH, D-69126 Heidelberg, Hatschekstr. 36, Deutschland  
Phonel +49 (0) 6221 3047-0, Fax -31

### 1.4 Labeling

Name plate with

- Manufacturer
- Type designation
- Date of manufacture
- Order number and serial number
- Weight

### 1.5 Environmental protection

Energy: The foot-mounted clutch does not use any electrical energy.

Materials: Steel, non-ferrous metals

Recycling: Steel parts are up to 100% recyclable.

## 2 Safety

### 2.1 Intended use

Foot-mounted clutches of type AL..G, AL..G-BR, AL..G-FAN, AL..G-BR-FAN are automatically switching couplings dependent on the direction of rotation. They transmit the torque in a force-locked manner.

They are used for dual-drives for pumps, blowers, generators etc. for start and turn drives e.g. for turbines.

Foot-mounted clutches may only be operated within the limitations of use outlined in section 2.5.

All of the specifications stated in the assembly and maintenance manual must be strictly adhered to.

Any claims due to damage arising from improper use are excluded. The operator carries sole liability for all damage arising from improper use.

### 2.2 Responsibility of the operator

The operator of the machine, in which the foot-mounted clutch is installed, is subject to the legal obligations concerning occupational safety.

The valid provisions for the site of operation as well as the safety and accident prevention regulations of the trade associations are to be observed. This, in particular, means that the operator:

- is aware of the valid occupational safety provisions.
- implements the necessary behavioral requirements for operation of the machine, in which the foot-mounted clutch is installed, at the site of operation.
- clearly defines responsibilities for installation, operation, maintenance and cleaning of the machine in which the foot-mounted clutch is installed.
- ensures that all staff members, who work at or with the machine in which the foot-mounted clutch is installed, are employed and have read and understood the operating manual. Moreover, he must, at regular intervals, provide training for personnel on how to handle the machine, in which the foot-mounted clutch is installed, and inform them of the potential dangers. In addition, the operator is responsible for ensuring that the machine in which the foot-mounted clutch is installed:
  - is always in perfect technical condition.
  - is maintained in accordance with the specified maintenance intervals.
  - has all its safety equipment checked regularly for completeness and functionality.

### 2.3 Assembly and maintenance personnel

	<b>WARNING</b>	<p><b>Risk of injury for insufficiently qualified personnel!</b>          Improper handling can cause significant personal injury and property damage. Therefore:</p> <ul style="list-style-type: none"> <li>➤ Only ever have tasks performed by those persons to whom the tasks have been assigned.</li> </ul>
---	----------------	---

Qualified personnel are those persons who, owing to their training, experience and instruction as well as their knowledge of relevant standards, provisions, accident prevention regulations and operating conditions, have been authorized by the person responsible for the safety of the plant to perform the requisite tasks and are able to recognize and avoid potential dangers in doing so. Knowledge of first-aid measures and on-site emergency equipment must also be included.

### 2.4 Personal protective equipment

It is necessary to wear personal protective equipment when handling the machine, in which the foot-mounted clutch is installed, to minimize health risks.

The necessary protective equipment such as work shoes, gloves, safety goggles etc. is to be put on prior to all tasks and kept on during the task.

## 2.5 Limitations of use

➤ Maximum permissible torque and maximum overrunning speeds:

Type				Size	Torque T <sub>KN</sub> [Nm]	max. Overrunning Speed (Driven Shafts) [min <sup>-1</sup> ]*
AL..G	AL..G-BR	AL..G-FAN	AL..G-BR-FAN			
X				30	500	5500
	-					-
		-				
X				50	2125	3400
	X					**
		X	X			
X				60	3500	2900
	X					**
		X	X			
X				70	5750	2600
	X					**
		X	X			
X				80	8500	2400
	X					**
		X	X			
X				90	14500	2000
	X					**
		X	X			
X				100	20000	1500
	X					**
		X	X			
X				120	31250	1300
	X					**
		X	X			
X				150	70000	1200
	X					**
		X	X			

\* at a reference temperature of 25°C / \*\* higher speeds on request

Table1 Overrunning speeds



- Limits for ambient temperature: -40°C to +50°C
- Maximum operating temperature: 90°C
- Input and output shaft should be connected by means of suitable separate shaft couplings according manufacturer recommendation
- Lubrication: Oil lubrication

	Ambient temperature			
	-40°C to -15°C	-15°C to +15°C	+15°C to +30°C	+30°C to +50°C
	Operating temperature			
	-20°C to +20°C	+10°C to +50°C	+40°C to +70°C	+50°C to +85°C
	Öl			
<b>ISO - VG DIN 51519</b>	10	22	46	100
<b>ARAL</b>	SUMOROL CM10	SUMOROL CM22	SUMUROL CM MOTANOLL HE 46	DEGOL CL100T MOTANOL HE 100
<b>BP</b>	ENERGOL CS10	ENERGOL CS22	ENERGOL CS46 ENERGOL RC-R 46	ENERGOL CS100 ENERGOL RC 100
<b>CASTROL</b>	-	-	AIRCOL PD 46	AIRCOL PD 100
<b>ESSO</b>	SPINESSO 10	SPINESSO 22	TERESSO T46	NUTO 100
<b>FUCHS</b>	RENOLIN MR3	RENOLIN DTA22	RENOLIN DTA46	RENOLIN MR30
<b>KLÜBER</b>	ISOFLEX PDP 38	ISOFLEX PDP 48	LAMORA HLP 46	LAMORA 100
<b>MOBIL</b>	VELOCITE No6	VELOCITE No10	MOBIL DTE 798	MOBIL DTE OIL HEAVY
<b>SHELL</b>	MORLINA 10	MORLINA 22	MORLINA 46	MORLINA 100
<b>TOTAL</b>	AZZOLA ZS10	AZZOLA ZS22	AZZOLA ZS46	AZZOLA ZS100

\* Alternatively we strongly recommend the use of multigrade oil SAE 10W-40 at working temperature between 0 °C and +80 °C.

Table 2 Lubricant recommendation

### 3 Structure and function

#### 3.1 Structure of foot-mounted clutch

##### Foot-mounted clutch

Pos. 1	Inner race
Pos. 2	Outer race
Pos. 4	Bearing
Pos. 5	Housing
Pos. 8	Rollers
Pos. 10	Eye bolt
Pos. 11	Lip seals
Pos. 13	Driven shaft
Pos. 14	Driving shaft
Pos. 15	Oil level gauge
Pos. 16	Drain plug
Pos. 17	Oil filling screw
Pos. 18	Vent screw
Pos. 19	Grease fitting
Pos. 20	End cover
Pos. 21	Cover
Pos. 22	Housing cover left
Pos. 23	Housing cover right
Pos. 25	O-Ring
Pos. 42	Hexagonal screws end cover
Pos. 43	Hexagonal screws cover
Pos. 44	Pin
Pos. 50	Fan (optional)
Pos. 60	Hand brake (optional)

Table 3 Bill of Material

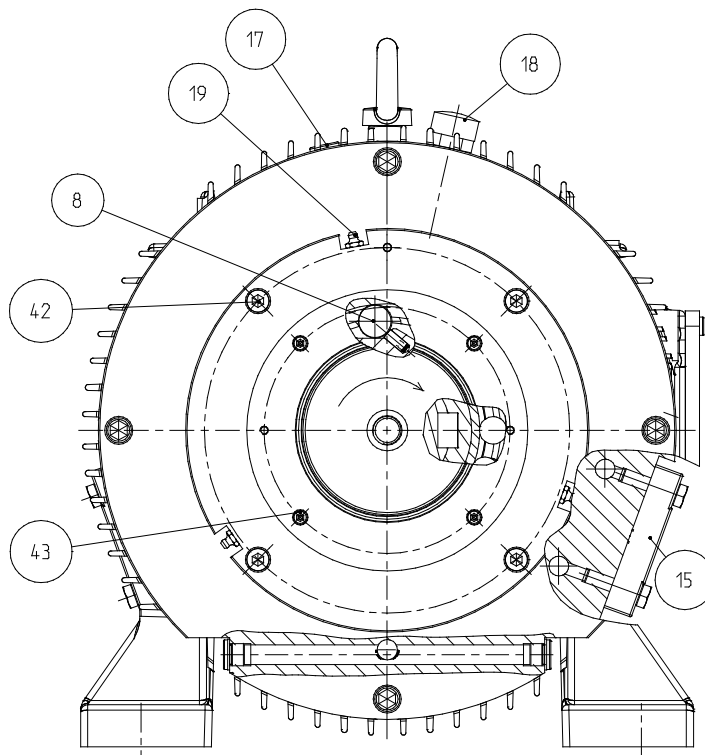
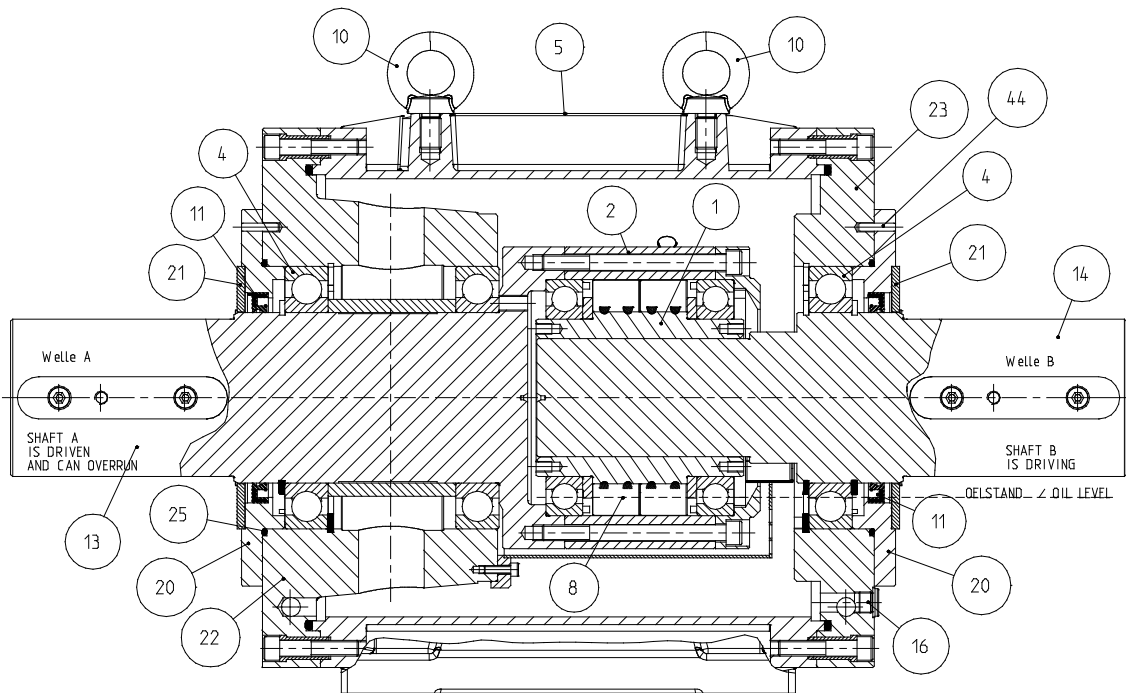

Fig. 1 Structure

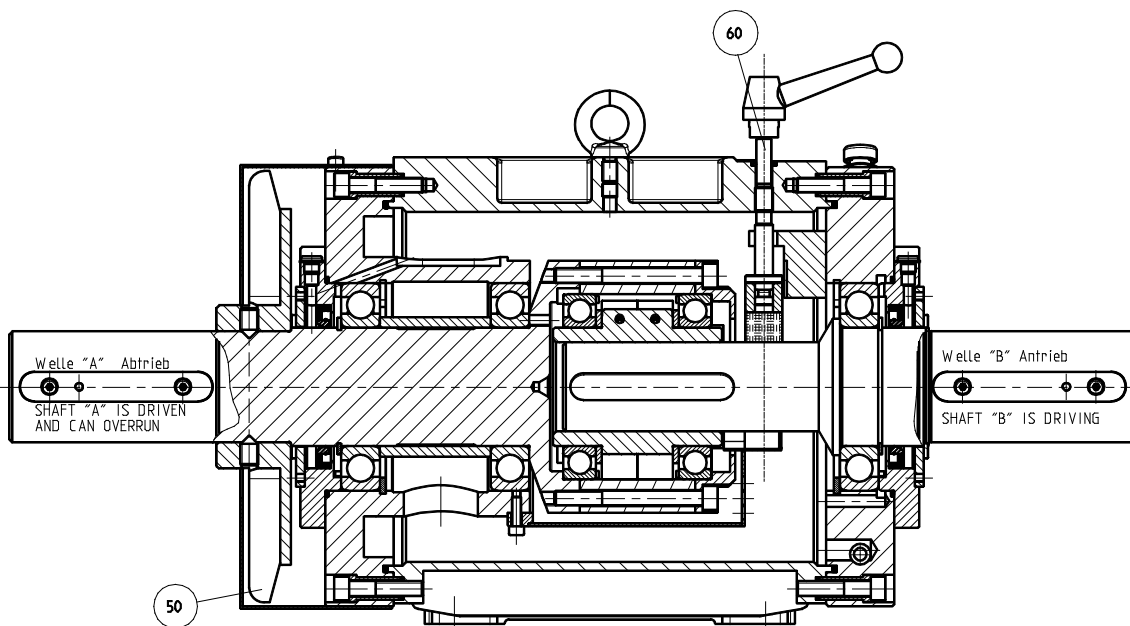

Fig.1b Design with brake (BR) and fan (FAN)

## 3.2 Function

Foot-mounted clutches of Type AL..G, AL..G-BR, AL..G-FAN, AL..G-BR-FAN are used as an overrunning clutch.

### 3.2.1 Operating mode:

During operation of the drive shaft (14) in the direction of driving operation the drive and driven shafts (13) are connected through the clutch-override mechanism in a friction-locked way.

In this operating state power is transmitted.

### 3.2.2 Overrun operation:

The overrunning clutch interrupts the connection of the drive and driven shafts as the driven part of the overrunning clutch is turned faster than the driving part.

### 3.2.3 Functioning of the foot-mounted clutch:

Foot-mounted clutches of Type AL..G, AL..G-BR, AL..G-FAN, AL..G-BR-FAN are fitted with ramps on which rollers are located. Springs and plungers ensure a permanent contact between inner race and outer race for an instant torque transmission.

While the outer race (see Fig.2) is turned in the direction of driving operation, the rollers ensure a connection between inner and outer race, so that torque and power can be transmitted.

The torque transmission is effected from the input shaft onto the output shaft. In driving operation the speeds of the inner and outer race are equal.

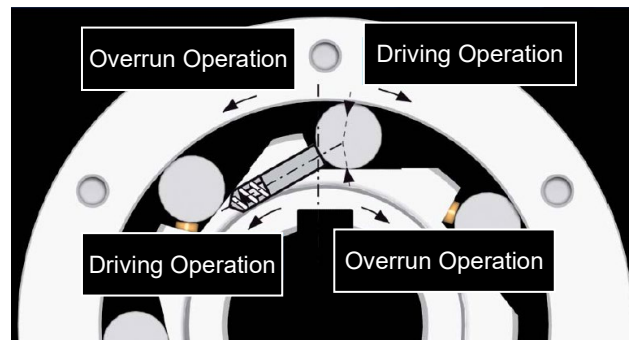



Fig.2 Driving/ Overrun Operation

While the outer race is turned in the direction of overrun operation, the force-locked connection between the inner and outer race (see Fig.2) will be interrupted. In overrun operation the speeds of the inner and outer race are different.

The hand brake (Pos. 60) prevents a slow roll operation due to drag torque of the stationary drive in overrun operation. Through the integration of fan unit (Pos. 50), warm air is transported away from the housing.

## 4 Transport and packaging

	<b>WARNING</b>	<b>Risk of injury due to the foot-mounted clutch falling down or tipping over!</b> The weight of the foot-mounted clutch can injure people and cause severe crushing. Therefore: <ul style="list-style-type: none"><li>➤ Use a pallet on which the foot-mounted clutch can be moved with a forklift.</li><li>➤ Use suitable lifting gear for lifting (slings, etc.) which is able to support the weight of the foot-mounted clutch.</li></ul>
---	----------------	---

	<b>NOTE</b>	The local provisions regarding the disposal of transport and packaging materials are to be observed.
---	-------------	--

The foot-mounted clutch including the heating elements are shipped in a box on the pallet.

Transport damage to the packaging and / or the foot-mounted clutch is to be reported to the respective transit company!

The foot-mounted clutch must be unpacked in a clean and dry environment!

## 5 Storage

### 5.1 Short-term storage

The housing is primed at the factory and the in- and output shaft comes with an oil film as corrosion protection. This corrosion protection is to be renewed at regular intervals. The frequency of these renewal intervals is dependent on the environmental conditions (temperature, moisture, salt content of the air, etc.) at the storage site.

The maximum storage period (short-term storage) is 6 months. Moreover, the backstop must have long-term storage corrosion protection applied to it.

Store packages under the following conditions:

- Do not keep outdoors
- Keep dry and free from dust
- Do not expose to aggressive media
- Keep away from direct sunlight
- Avoid mechanical shocks and vibrations
- Storage temperature: -10 to +60 °C

- Relative humidity: maximum 95%, non-condensing

## 5.2 Long-term storage



To this end the foot-mounted clutch has to be completely filled with oil and the in- and output shaft must be preserved with an anticorrosive agent such as "TECTYL Amber Spray" or with a similar product. The corrosion protection must be checked after a period not exceeding one year or else depending on the environmental conditions (temperature, moisture, salt content of the air, etc.) at the storage site.

Store packages under the following conditions:

- Do not keep outdoors
- Keep dry and free from dust
- Do not expose to aggressive media
- Keep away from direct sunlight
- Avoid mechanical shocks and vibrations
- Storage temperature: -10 to +60 °C
- Relative humidity: maximum 95%, non-condensing

## 6 Installation

### 6.1 Testing the direction of rotating

	<b>WARNING</b>	<p><b>Risk of injury due to incorrect assembly!</b>          Faulty installation and maintenance can cause severe property damage and personal injury.          Installation, maintenance and repair work may only be performed by personnel with the requisite training and expertise.</p>
	<b>WARNING</b>	<p><b>Risk of injury due to moving components!</b>          Rotating driven components can cause the most severe injuries.          Therefore, during operation:</p> <ul style="list-style-type: none"> <li>➤ It is strictly forbidden for persons to loiter in the danger zone or in its immediate vicinity.</li> <li>➤ Do not disable, render unusable or circumvent safety equipment and / or safety functions.</li> </ul> <p>Prior to entering the danger zone:</p> <ul style="list-style-type: none"> <li>➤ Switch off the power supply and secure it against being switched on again.</li> <li>➤ Wait for lagging components to come to a standstill.</li> </ul>

The direction of rotation must be checked prior to installation.

The installation must be made so that the propulsion machinery is connected with the drive shaft (14) and the driven machine is connected with the driven shaft (13).

Procedural steps:

- Turn the drive shaft (14) in the direction of engine rotation. In doing so, ensure that the driven shaft (13) rotates itself and cannot be hold.
- The hand brake (Pos.60) must be released.

A change of direction can only be performed in the factory by Stieber.

## 6.2 Assembly

	<b>WARNING</b>	<p><b>Risk of injury due to incorrect assembly!</b>          Faulty installation and maintenance can cause severe property damage and personal injury.          Installation, maintenance and repair work may only be performed by personnel with the requisite training and expertise.</p>
---	----------------	---

	<b>WARNING</b>	<p><b>Risk of injury due to moving components!</b>          Rotating driven components can cause the most severe injuries.          Therefore, during operation:</p> <ul style="list-style-type: none"> <li>➤ It is strictly forbidden for persons to loiter in the danger zone or in its immediate vicinity.</li> <li>➤ Do not disable, render unusable or circumvent safety equipment and / or safety functions.</li> </ul> <p>Prior to entering the danger zone:</p> <ul style="list-style-type: none"> <li>➤ Switch off the power supply and secure it against being switched on again.</li> <li>➤ Wait for lagging components to come to a standstill.</li> </ul>
---	----------------	--

Procedural steps:

	<b>NOTE</b>	<p><b>Mounting couplings!</b>          Couplings must be mounted according to the information provided by the coupling manufacturer. The clutch hubs may not be driven onto the shaft by applying hammer blows, as the in the foot-mounted clutch built-in roller bearings may be damaged in the process.</p>
---	-------------	---

	<b>NOTE</b>	<p><b>Coupling alignment!</b>          Exact coupling alignment greatly increases the service life of the foot-mounted clutch and of the coupling transmission elements. The parallel and angular displacement of the shaft must be according to the information provided by the coupling manufacturer. The axial thermal expansion of the drive shaft has to be considered.</p>
---	-------------	--

- Lift the foot-mounted clutch out of the packaging using a hoist attached to the eye bolts.



- A secure anchorage of the foot-mounted clutch in the ground must be ensured.
- Thoroughly clean and grease the shafts (13+14) of the foot-mounted clutch.
- Fix the propulsion machinery and the driven machine to ends of the shafts (13+14).
- Unscrew vent screw (18).
- Unscrew oil filling screw (17).
- Fill the foot-mounted clutch with oil (see table 4) within the marked range of the oil level gauge.
- Screw the oil filling screw (17) with seal and vent screw (18).

### 6.3 Lubrication

Prior to commissioning, the foot-mounted clutches of type AL..G, AL..G-BR, AL..G-FAN, AL..G-BR-FAN must be filled with oil (see table 4).

Oil volume & oil grade									
Type AL..G, AL..G-BR, AL..G-FAN, AL..G-BR-FAN	30-G1	50-G3	60-G3	70-G3	80-G4	90-G4	100-G4	120-G5	150-G5
Oil grade	See table 2 in chapter 2.5 "Limitations of use"								
Oil volume [L]	0,75	2,5	2,75	2	6	5,8	4,75	25	17

Table 4 Oil volume

Procedural steps:

- Unscrew vent screw (18).
- Unscrew oil filling screw (17).
- Fill the foot-mounted clutch with oil (see table 4) within the marked range of the oil level gauge.
- Screw the oil filling screw (17) with seal and vent screw (18).



#### NOTE

Check oil filling screw and drain plug for leaks and firm fitting!

## 6.4 Mounting example

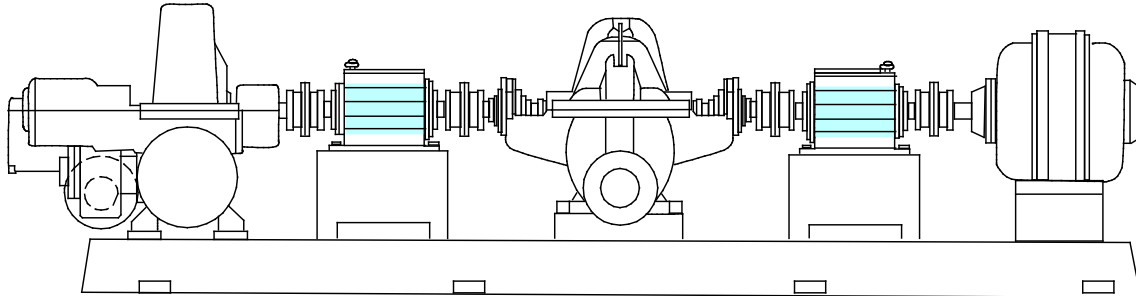



Fig. 3: Mounting example

## 7 Commissioning

Prior to commissioning, the foot-mounted clutches of type AL..G, AL..G-BR, AL..G-FAN, AL..G-BR-FAN must be filled with oil (see table 4 Oil volume).

	<b>WARNING</b>	<b>Risk of injury due to moving components!</b> Rotating driven components can cause the most severe injuries. Therefore, during operation: <ul style="list-style-type: none"> <li>➤ Oil change may only be carried out with the system stopped!</li> </ul>
---	----------------	--

	<b>WARNING</b>	<b>Risk of scalding from hot surfaces!</b> There is a risk of sustaining burns or scalds on hot surfaces during operation. Therefore: <ul style="list-style-type: none"> <li>➤ Do not touch the foot-mounted clutch during operation!</li> </ul>
---	----------------	---

Procedural steps:

- Unscrew vent screw (18).
- Unscrew oil filling screw (17).
- Fill the foot-mounted clutch with oil (see table 4) within the marked range of the oil level gauge.
- Screw the oil filling screw (17) with seal and vent screw (18).

**NOTE**

Check oil filling screw and drain plug for leaks and firm fitting!

- Screw the oil filling screw (17) with seal and vent screw (18).

The oil level must be checked and corrected with an operating time of 10 minutes.  
The oil level must reach the mark (15) in operation.

## 8 Operation

**WARNING****Risk of injury due to incorrect operation!**

When the system is in operation, the hand brake must be released. Therefore, during operation:

- Before putting the stationary drive into operation, release the hand brake by hand with the brake lever (Pos.60)!

**WARNING****Risk of injury due to incorrect assembly!**

Faulty installation and maintenance can cause severe property damage and personal injury.

Installation, maintenance and repair work may only be performed by personnel with the requisite training and expertise.

**WARNING****Risk of injury due to moving components!**

Rotating driven components can cause the most severe injuries. Therefore, during operation:

- It is strictly forbidden for persons to loiter in the danger zone or in its immediate vicinity.
- Do not disable, render unusable or circumvent safety equipment and / or safety functions.

Prior to entering the danger zone:

- Switch off the power supply and secure it against being switched on again.
- Wait for lagging components to come to a standstill.

**WARNING****Risk of scalding from hot surfaces!**

There is a risk of sustaining burns or scalds on hot surfaces during operation. Therefore:

- Do not touch the foot-mounted clutch during operation!

## 8.1 Oil level control

When the system is running the oil level must be checked monthly. Oil levels must be in the area of the top of the mark on the oil level gauge (15).

If necessary, add oil. The refilling operation can be made as described below, during operation.

Procedural steps:

- Unscrew vent screw (18).
- Unscrew oil filling screw (17).
- Refill some oil, until it reaches the middle of the oil level gauge (15).
- Screw the oil filling screw (17).
- Screw the vent screw (18).



### NOTE

Check oil filling screw and drain plug for leaks and firm fitting!

## 9 Maintenance

### 9.1 Oil change

First oil change has to be made after start-up after approx. 8000 operating hours, but at latest after 1 year.



### WARNING

#### **Risk of injury due to moving components!**

Rotating driven components can cause the most severe injuries. Therefore, during operation:

- Oil change may only be carried out with the system stopped!



### WARNING

#### **Risk of scalding from hot surfaces!**

There is a risk of sustaining burns or scalds on hot surfaces during operation. Therefore:

- Do not touch the foot-mounted clutch during operation!

Procedural steps:

- Unscrew vent screw (18).
- Unscrew oil filling screw (17).

**NOTE**

At waste oil disposal the according local disposal regulations are to be followed!

- Remove the drain plug (16) and drain out the oil. Place appropriate collecting buckets with a suitable capacity .
- Mount the drain plug (16).
- Fill up the foot-mounted clutch with oil (see table 4).

**NOTE**

Check oil filling screw and drain plug for leaks and firm fitting!

- Screw the oil filling screw (17) with seal and vent screw (18).
- The oil level must be checked and corrected with an operating time of 10 minutes. The oil level must reach the mark (15) in operation.
- Fill the grease chamber (Pos11) with new grease.

## 10 Disassembly

**WARNING****Risk of injury due to moving components!**

Rotating driven components can cause the most severe injuries. Therefore, during operation:

- It is strictly forbidden for persons to loiter in the danger zone or in its immediate vicinity.
- Do not disable, render unusable or circumvent safety equipment and / or safety functions.

Prior to entering the danger zone:

- Switch off the power supply and secure it against being switched on again.
- Wait for lagging components to come to a standstill.

**WARNING****Risk of scalding from hot surfaces!**

There is a risk of sustaining burns or scalds on hot surfaces during operation. Therefore:

- Do not touch the foot-mounted clutch during operation!

Procedural steps:

- Remove the propulsion machinery and the driven machine from the shafts (13/14).
- Unscrew vent screw (18).

- Unscrew oil filling screw (17).

	<b>NOTE</b>	At waste oil disposal the according local disposal regulations are to be followed!
---	-------------	--

- Remove the drain plug (16) and drain out the oil. Place appropriate collecting buckets with a suitable capacity.
- Screw drain plug (16), oil filling screw (17) with seal and vent screw (18).
- Remove the retainer bolts from the housing base.
- Lift the foot-mounted clutch using a hoist attached to the eye bolts.

## 11 Disposal

	<b>NOTE</b>	The local provisions regarding the disposal of metallic components and any lubricants present are to be observed.
--	-------------	---

The foot-mounted clutch is comprised of metallic materials which are coated with grease or oil. Metallic materials are fully recyclable. Lubricants and anticorrosive agents are to be disposed of separately. The local disposal provisions are to be observed in this regard.

## 12 Faults

The manufacturer is to be contacted immediately should any faults arise.

STIEBER GMBH, 69126 Heidelberg, Hatschekstr. 36, Germany  
 Phone +49 (0) 6221 3047-0, Fax -31

## 13 Spare parts

	<b>WARNING</b>	<p><b>Risk of injury by incorrect spare parts!</b>          Incorrect or faulty replacement parts may cause damage, faulty function or total breakdown, as well as impairing safety. Therefore:</p> <ul style="list-style-type: none"> <li>➤ Use only the manufacturer's original spare parts.</li> </ul>
---	----------------	---

Procure spare parts from authorized dealers or directly from the manufacturer.

## 14 Accessory

### 14.1 Hand brake

	<b>WARNING</b>	<p><b>Risk of injury due to moving components!</b>          The handbrake cannot be used as protection for maintenance work on the drive during the normal overrun operation!          Therefore:</p> <ul style="list-style-type: none"> <li>➤ Installation, maintenance and repair work may only be carried out with the system stopped!</li> </ul>
---	----------------	--

	<b>CAUTION</b>	<p><b>Damage to property due to actuating the handbrake!</b>          The handbrake is only preventing the drive from being carried along during overrun operation.          Therefore during the operation of the drive:</p> <ul style="list-style-type: none"> <li>➤ Do not use the hand brake for braking of rotating masses when the system stops!</li> </ul> <p>When the system starts:</p> <ul style="list-style-type: none"> <li>➤ Release the handbrake via the handle.</li> </ul>
---	----------------	--

The hand brake prevents the drive shaft from rotation during overrunning.

To do this the brake must be securely applied by rotating the hand wheel (lever) clockwise.

When rotating the hand wheel anti-clockwise, the brake will be released.

The hand brake is not suitable for the stopping of the whole drive system.